

Nail Splitters

- Our nail splitters have the true feel of superb craftsmanship. The cutting edge is expertly ground and specially heat treated and the grooved handles provide a sure grip.
- Nail splitters should not be used on thick or mycotic nails, use nail nippers for these applications.

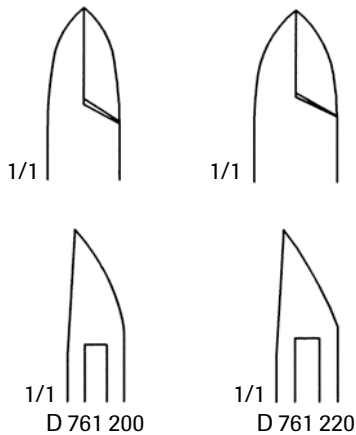

This short jaw design provides increased leverage for easier cutting of thick nails, causing less strain on the hand and splitter.

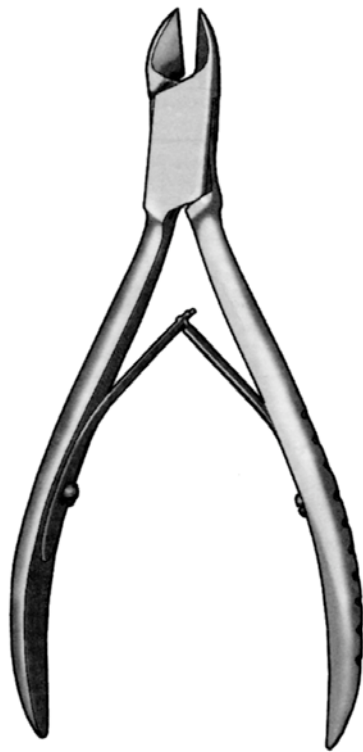

P.I. Short Jaw Nail Splitter

Stainless

D 761 200 5"

D 761 220 6"

D R11 330 Replacement Springs (2)

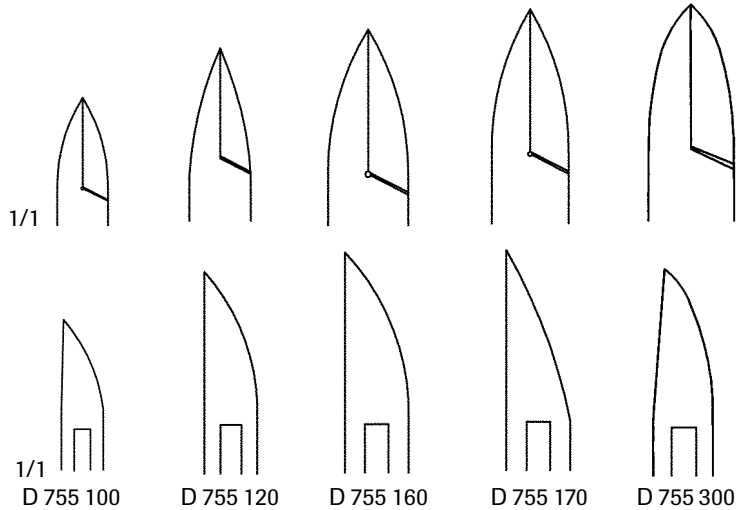

Nail Splitter

Stainless

D 755 100 4"

D 755 120 4-1/2"

D 755 160 5" Medium Jaw

D 755 170 5" Narrow Jaw

D 755 300 6"

D R11 330 Replacement Springs (2)

D R11 440 Replacement Springs (2)
(for D 755 100 only)

Nail Splitters and Tissue Nippers

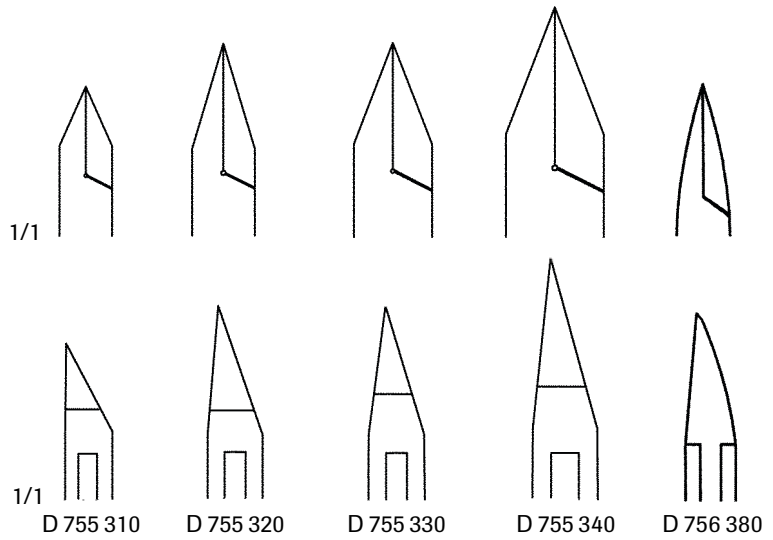
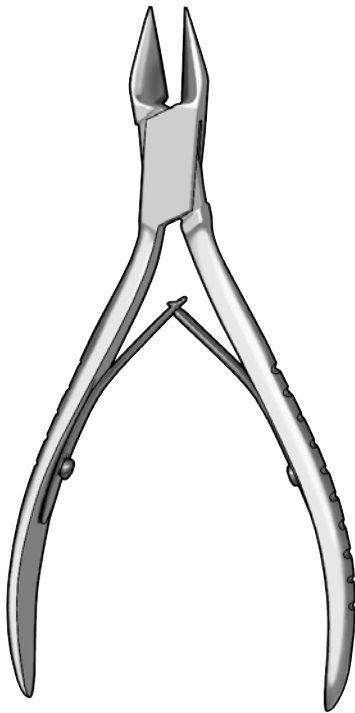

Nail Splitter

Stainless

D 755 310 4" Tapered

D 755 320 4-1/2" Tapered

D 755 330 5" Tapered

D 755 340 6" Tapered

D 756 380 4-1/2" Delicate

D R11 330 Replacement Springs (2)

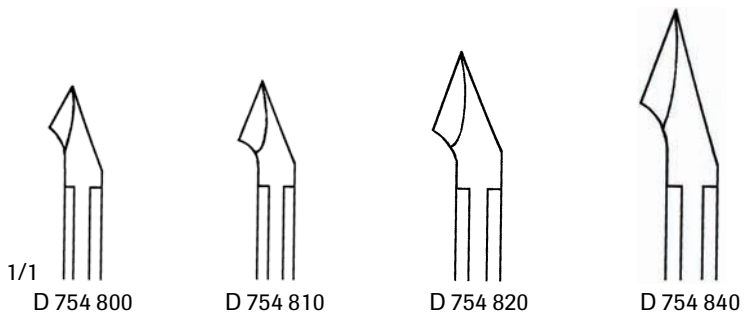
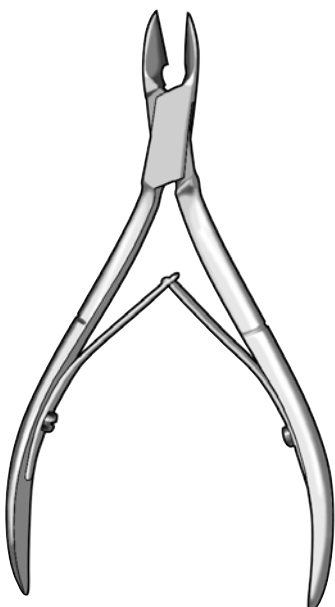

Tissue Nipper

Stainless

D 754 800 4" 6mm

D 754 810 4" 9mm

D 754 820 4-1/2" 11mm

D 754 840 5" 14mm

D R11 330 Replacement Springs (2)

Hand Instruments

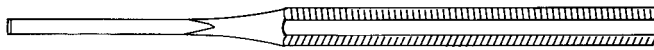

Nail Splitter

D 757 470

6" Small Blade, Straight, Single Ended



D 757 520

6" Small Blade, Angled, Single Ended

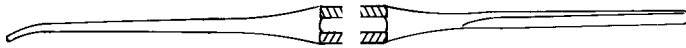

Probe and Packer

D 756 850

6" Double Ended

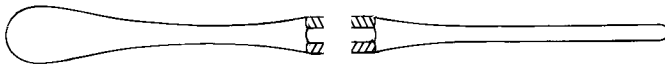

Spatula and Packer

D 756 880

5-3/4" Double Ended

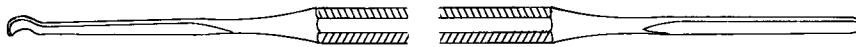

Excavator and Packer

D 756 920

5-3/4" Double Ended

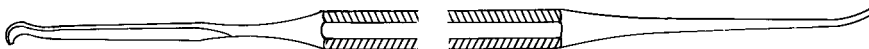

Probe and Excavator

D 757 080

6" Double Ended

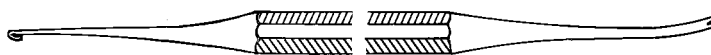

Johnson-Tucker Hook and Fork

D 759 800

6-1/2" Double Ended, Delicate