

Adson Tissue and Dressing Forceps

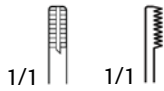

Adson Brown Tissue Forceps

D 452 820
4-3/4" 9x9 Teeth, Side Grasping

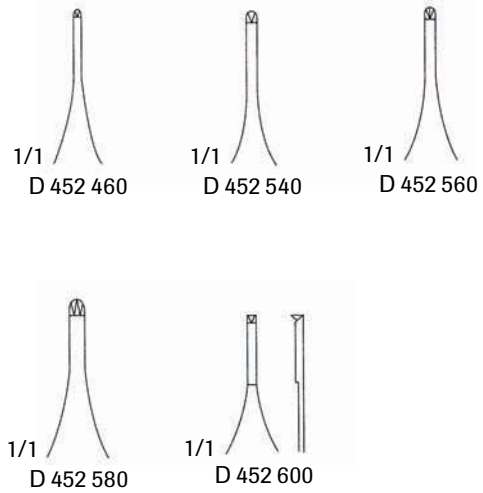

Adson Tissue Forceps

D 452 460 4-3/4" 1x2 Teeth, Micro Tip
D 452 530 4-3/4" 1x2 Teeth, Serrated Tip
D 452 540 4-3/4" 1x2 Teeth, Delicate Tip
D 452 560 4-3/4" 1x2 Teeth, Standard Tip
D 452 600 4-3/4" 1x2 Teeth, Delicate Tip with Tying Platform
D 452 580 4-3/4" 2x3 Teeth

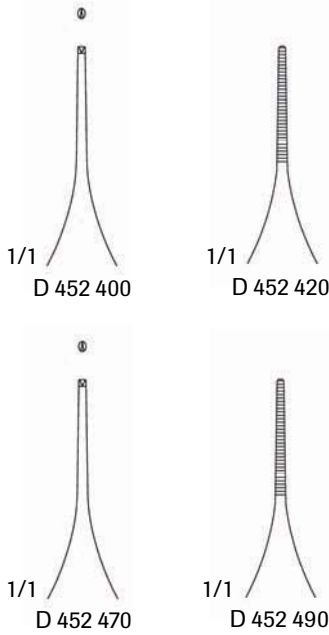

Adson Dressing and Tissue Forceps

D 452 400 6" 1x2 Teeth
D 452 420 6" Serrated
D 452 470 6" 1x2 Teeth, Micro Tip
D 452 490 6" Serrated, Micro Tip

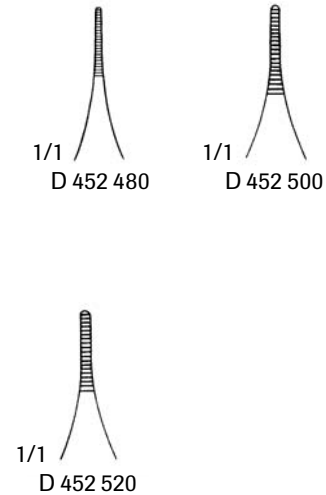

Adson Dressing Forceps

4-3/4" Serrated
D 452 480 Micro Tip
D 452 500 Delicate Tip
D 452 520 Standard Tip
D 452 620 Carbide Tip

Dressing Forceps



Dressing Forceps

Serrated

- D 442 660 4-1/2"
- D 442 700 5"
- D 442 740 5-1/2"
- D 442 780 6"
- D 442 840 8"
- D 443 560 5-1/2" Extra-Narrow

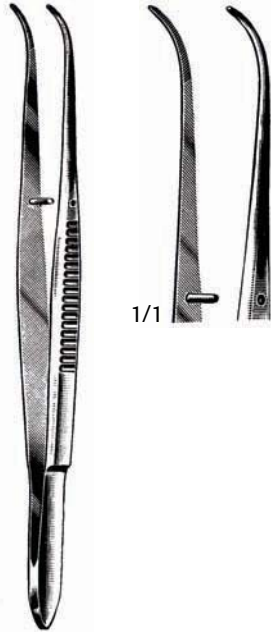

Dressing Forceps

D 442 720
5" Curved, Serrated Fine Point

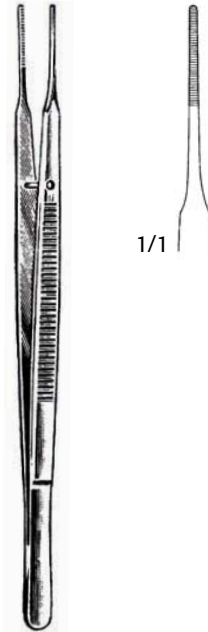

Gerald Dressing Forceps

D 443 700
7" Straight, Serrated

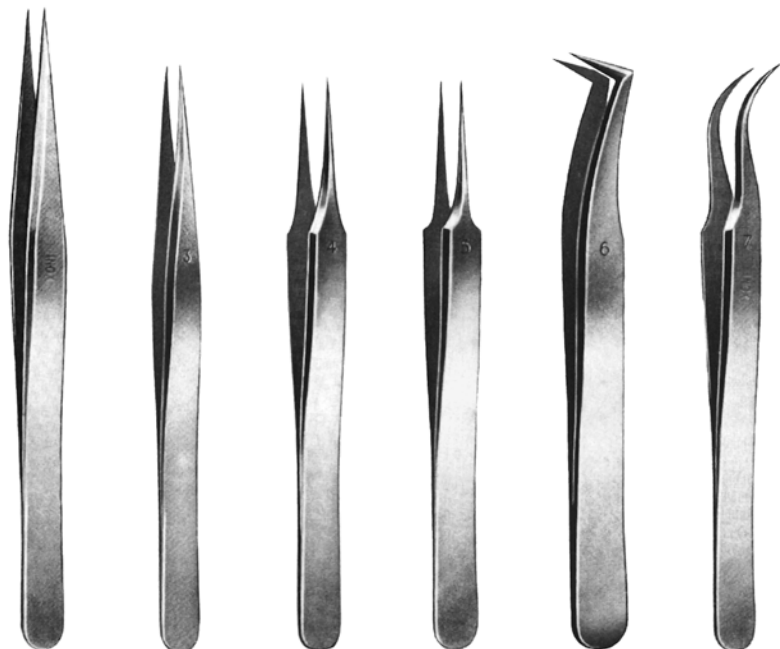

- D 456 400
- D 456 410
- D 456 420
- D 456 430
- D 456 450
- D 456 460

Swiss Jewelers Style Forceps

- D 456 400
#3 4-3/4" Narrow Fine Tip
- D 456 410
#3C 4-3/8" Narrow Fine Tip
- D 456 420
#4 4-3/8" Fine Tip
- D 456 430
#5 4-3/8" Extra Fine Tip
- D 456 450
#6 4-1/2" Angled Pickup Tip
- D 456 460
#7 4-1/2" Curved Fine Tip